

Assembling and Powering-up your Camera System

Please bring together all parts. Make certain that during assembly the camera shutter cover stays in place to avoid damage to the metal iris. Only remove the cover when you are ready to connect the camera to your optical path. Please connect the various system components as follows:

CAUTION: Always plug your camera power cord into the camera “DC Power Jack” first, before applying AC power to the power supply. “Hot Plugging” the camera may result in a blown power supply fuse.

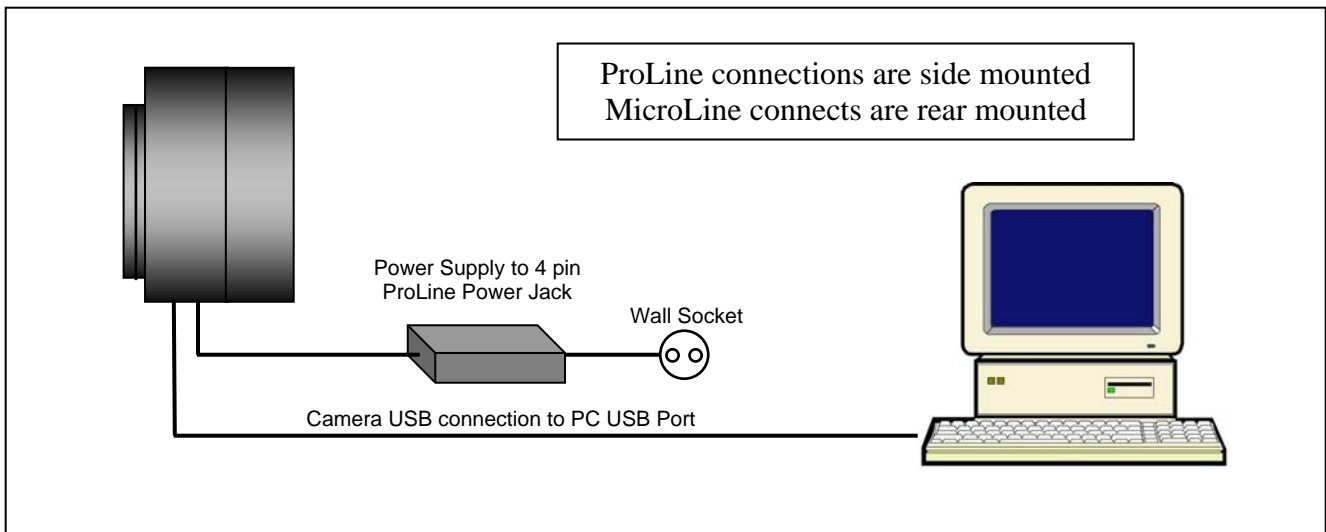

FINGER LAKES INSTRUMENTATION - PROLINE IMAGING SYSTEM

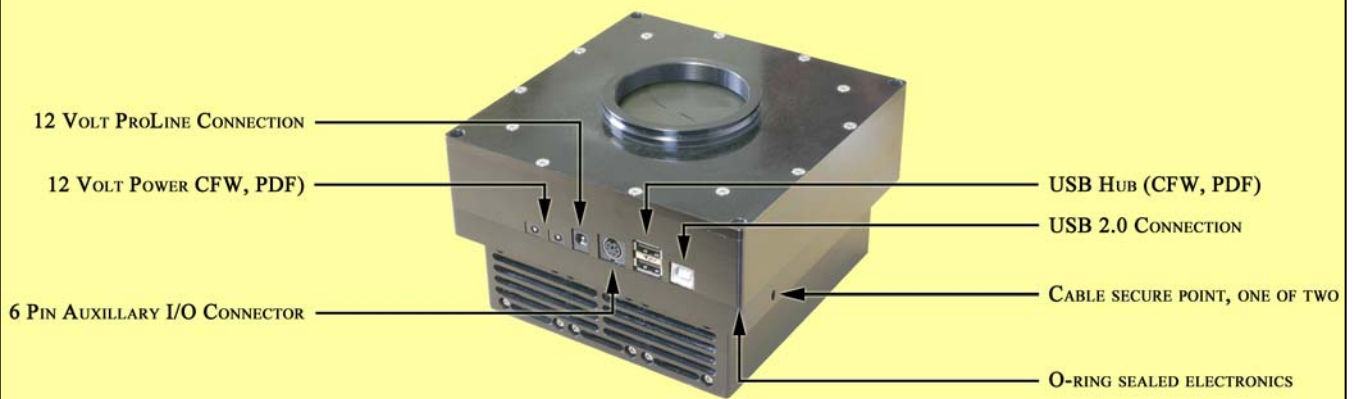

1. Attach the USB cable to your ProLine or MicroLine camera.
2. Attach the USB cable to your PC.
3. Plug in the 12 volt power supply 4-pin “DC Power Jack” connector into your camera.
4. Plug in the ProLine or MicroLine power supply unit into a wall socket or switched AC power strip.
5. Ensure that the camera’s fans are running.

Confirming Driver Installation

To ascertain that the camera drivers have been installed properly you can do so at any time if required.



At the Windows Desktop right-click on the **My Computer** icon

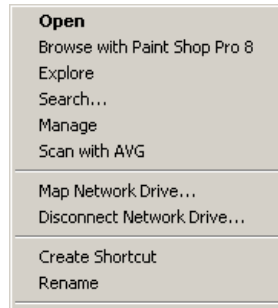

Click on **Properties**.

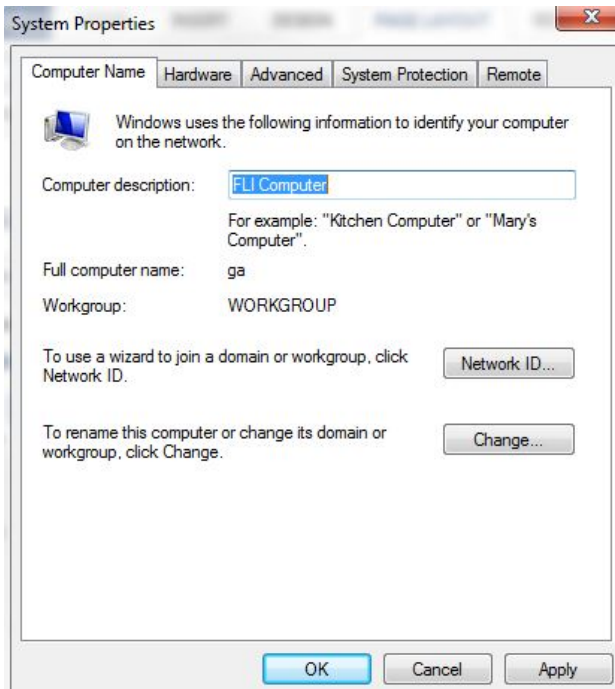

Click on the **Hardware** tab.

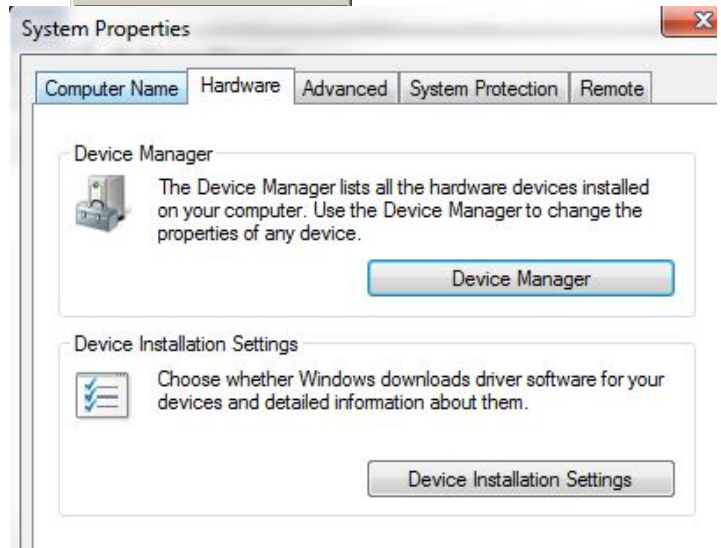

Click on the **Device Manager** button.

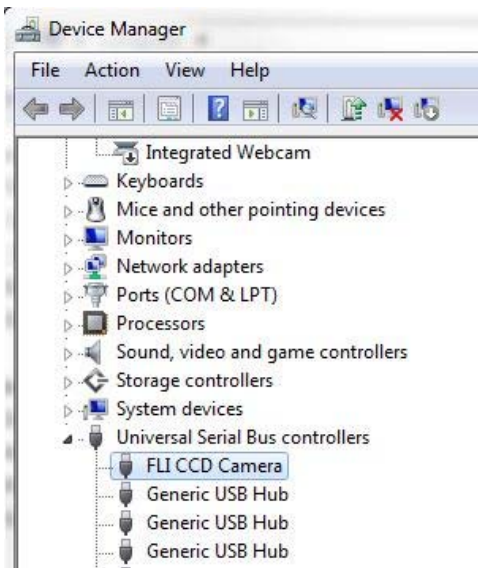

Click on **Universal Serial Bus Controllers**. The **FLI [type] Camera** entry should be present in the list.

If the **FLI [type] Camera** does not appear in the list you will need to re-install FLIGrab.

Please follow the installation instructions very closely.

FLIGrab is a Windows based program and allows you to fully control your camera. The following two sections will show you how to capture your first image as well as how to focus your camera.

Capturing your First Image

Ensure that your FLI camera is connected to your computer and that power is switched on. The fan on your camera should now be turning. Double click on the FLIGrab icon to open the application.

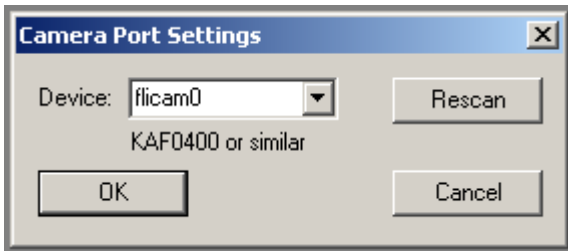

FLIGrab will automatically identify your camera. Click on OK to proceed.

If FLIGrab fails to find your camera, check all connections. Stretched cables can cause connectivity problems and/or system instability.

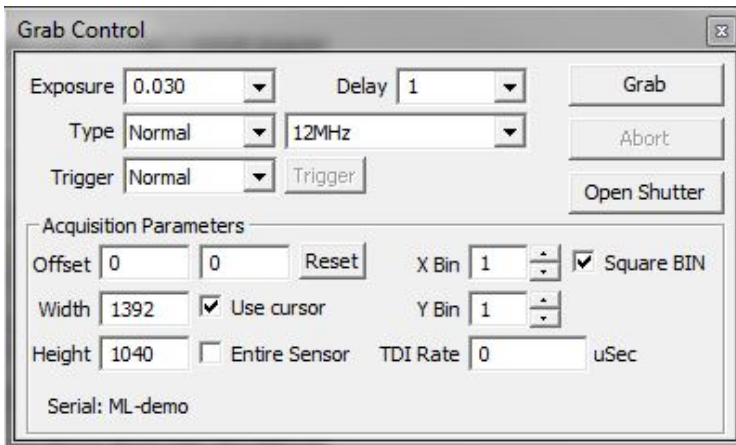

Click on File, and then click on Camera Control (Ctrl+W). Click on the Exposure tab to select it.

Set the fields as in the example on the left. If you are imaging during daytime set Exposure to 0.03 seconds. If you are testing your camera at night time a minimum 0.3 seconds exposure is recommended.

Note that overexposing can produce a black flat frame and not a bright frame.

Ideally, you would use the Grab command after the camera system is set up and focused. Click on Grab. You should be able to hear the shutter opening and closing while capturing the image.

It will take a few seconds for the image to appear on the computer screen. The image on your computer screen is likely to be out of focus.

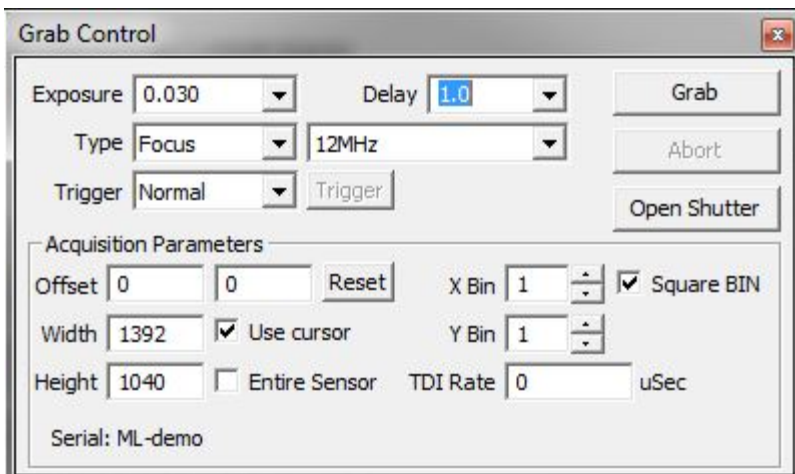

Focusing your Camera

Click on File, and then click on Camera Control (Ctrl+W). Click on the Focus tab to select it.

Set the fields as in the example on the left. If you are imaging during daytime set Exposure to 0.03 seconds. If you are testing your camera at night time a

minimum 0.3 seconds exposure is recommended.

Note that overexposing can produce a black flat frame and not a bright frame.

Click on the Focus button. You will notice that the camera will start taking images at a slow rate and transferring them to the screen. Click on the Abort button to abort. Wait for the camera to finish transferring

the last frame to the computer screen. The slow frame rate makes focusing difficult.

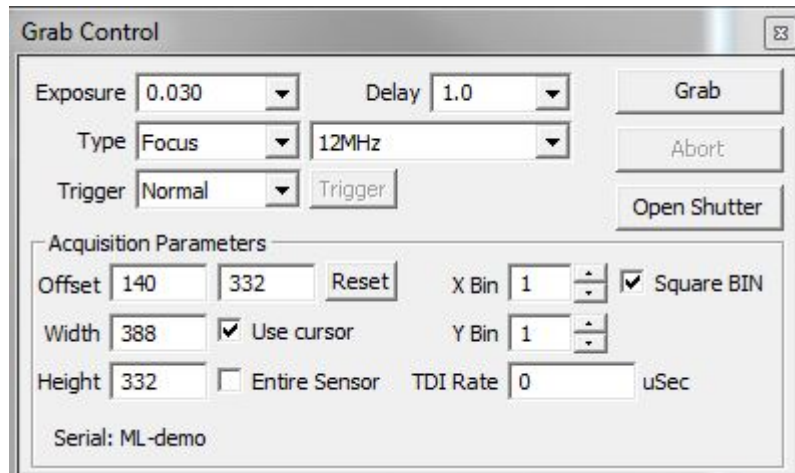

To increase the frame rate you will need to set the camera so that it will only transfer a part of the whole image captured during the focusing process, i.e. the centre area. This makes focusing more intuitive and easier to achieve.

Set the fields as in the example on the left. If you are imaging during daytime set Exposure to 0.03 seconds. If you are testing your camera at night time a minimum 0.3 seconds exposure is recommended

Note that overexposing can produce a black flat frame and not a bright frame.

Once you have focused your camera you will be able to capture your first focused image.

Please refer to **Capturing your First Image** above.

FLIGrab Camera Control Software

FLIGrab is a Windows based program. The menu structure of FLIGrab changes depending upon the circumstances. Options are added when a camera is present and when an image file is open.

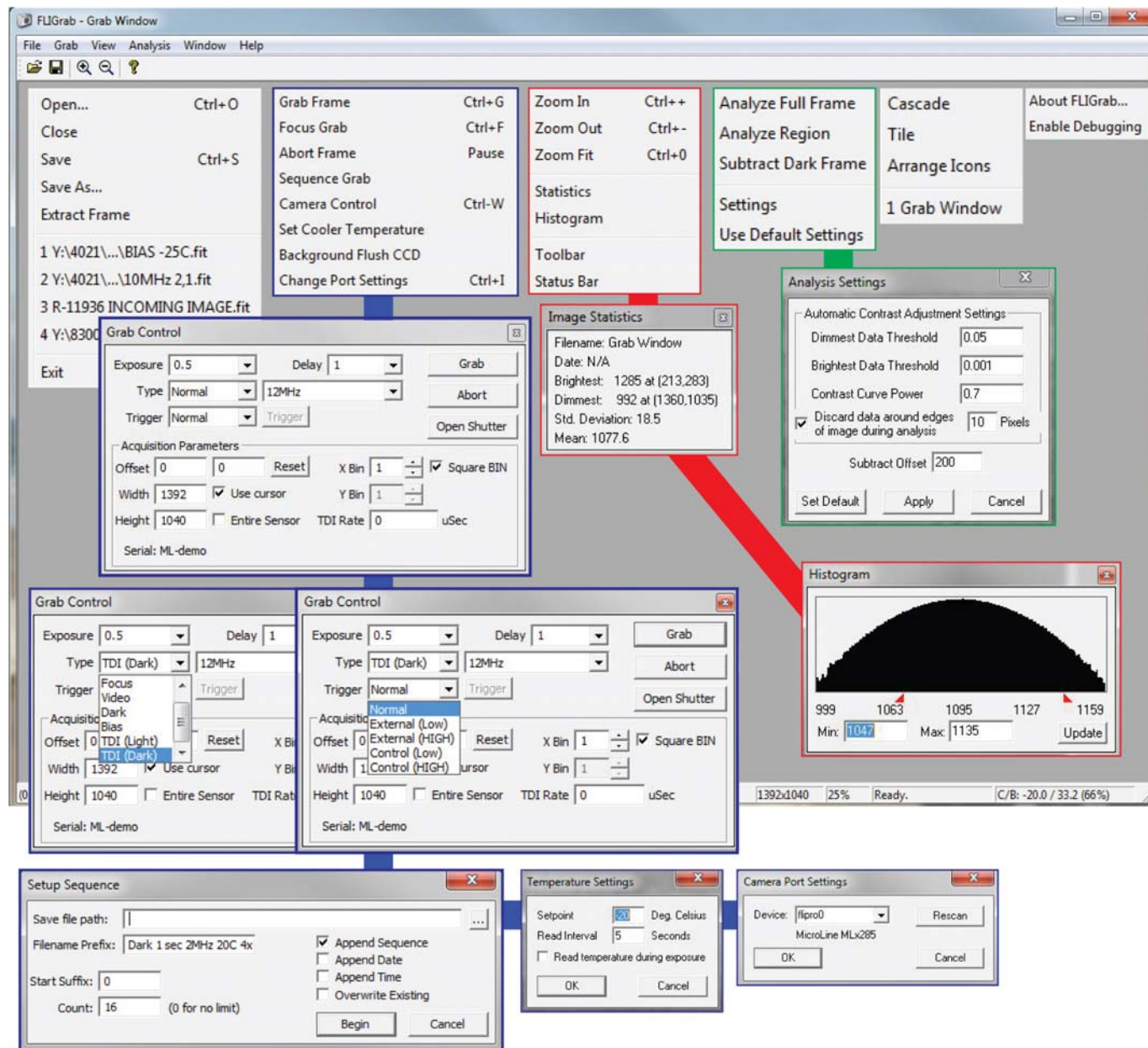

Status Bar

The Status Bar is located on the lowest-most portion of FLIGrab. It provides information about FLIGrab activities and is continuously updated. When a ProLine or MicroLine camera is connected and initialized, the Status Bar will display the camera temperature, connection status, and exposure status.

When an image is open, the image size, view zoom ratio, pixel value and location will be indicated on the Status Bar.

Shortcut Keys

Frequently employed menu choices can also be reached by using shortcut keys. Each shortcut key can be found to the right of each command as seen in the menu. Additionally, a list of shortcut keys can be found by selecting the Help menu. For example, holding down the "Ctrl" key and then hitting the "G" will open the Grab Window. You may find that once learned, these shortcuts increase productivity and speed of operation on the most frequently performed functions.

Menu Bar

The upper most portion of the screen contains the pull-down menus, which include File, Grab, View, Analyze, Window and Help. Each menu item selection further comprises functions that are similar in nature to one another.

File

Open: This command loads an IMG or FITS* file format from disk into memory where it can be displayed or processed. When the Open window is displayed, you will be able to select files by moving through the directory structure. The shortcut key is Ctrl + O.

Close: Closes the currently opened image window by removing it from memory. If the image has changed, you will be prompted to save your changes before the window closes. The shortcut key is Ctrl + F4.

Save: Saves the currently opened image to disk. The same file name that was used to open the file will be used with the Save command. The shortcut key is Ctrl + S.

Save As: Allows you to save the currently opened image in a different file format or with a different name.

Recent File: The most recently opened files are displayed, allowing you to preview and select files that have been recently accessed.

Exit: Exits FLIGrab. The shortcut key is Alt + F4.

* Many professional astronomical image-processing programs support the FITS format (Flexible Image Transport System). The format is described in "Implementation of the Flexible Image Transport System (FITS)" published by NOST, NASA/OSSA Office of Standards and Technology, NASA Goddard Space Flight Center, Greenbelt, MD.

Grab

Grab Frame: The Grab command is used to take a single exposure or begin a sequence of exposures using the Save Filename Format String command. Ideally, you would use the Grab command after the camera system is set up and focused. There are several options associated with the Grab command that expand its usage. You can choose to take a Normal, Bias or Dark Frame exposure. For exposure longer than a minute, you may wish to take matching (duration and temperature settings) Dark Frames and store them on disk for later manual subtraction from Light frames.

Another feature of the Grab command is that you don't always have to take full frame images. You can choose to take sub-frames, which can be selected with your mouse cursor or by simply typing in the coordinates. A sub-frame has the benefit of reducing the image file size and associated storage requirements; it is most useful for small objects that do not require the full field of view that a full-frame provides.

There are several other exposure options that are available under the “Advanced Grab Settings” command. These options will allow for automated grabs, predetermined file name suffixes and more. The shortcut key is Ctrl + G.

Grab Settings

Focus Delay: The delay in seconds between each focus integration. The delay is useful when you're focusing the system; allowing you time to make a change and let the optical system settle before another exposure is begun.

Frame Delay: The delay in seconds between each exposure. This feature is useful if you are using a robotic mount and require time in-between exposures, to center a new object.

BIN factor is square: For example 1x1, 2x2, ... , 16x16.

Adjust contrast during focus: FLIGrab will automatically adjust the image contrast for each focus display.

Shutter opens with external trigger: Refer to External Triggering on Page 18.

Set Cooler Temperature: This selection sets the operating temperature for the Thermal Electric cooling device. (The TEC cooler is used to cool your camera which in turn reduces the rate of dark current build-up during an exposure). **See Page 14 program details.**

Re-Initialize Camera: Send the initialization command to the camera should you lose power or camera connection.

View

Zoom In: Incrementally zoom into an image (800% maximum).

Zoom Out: Incrementally zoom out of an image (12% minimum).

Zoom Fit: Automatically adjusts an image to fit the current window size.

Statistics: Select or deselect this option to view the Image Statistics.

Histogram: Select or deselect this option to view an adjustable Histogram for the opened image. You can move the red histogram pointers to adjust an image's screen display settings.

Toolbar: Select or deselect this option to view the Toolbar.

Status Bar: Select or deselect this option to view the Status Bar.

Analyze

Analyze Full Frame: FLIGrab will automatically analyze the full frame according to the default settings.

Analyze Region: Selecting this option will initiate a crosshair for image selection.

Dimmest Data Threshold: (Background brightness) smaller values will produce a brighter background.

Brightest Data Threshold: (Object brightness) larger values will produce a brighter object.

Contrast Curve Power: Adjust the object's contrast; the steeper the curve the more contrast.

Set Default: Selecting the "Set Default" icon will save the current settings as your default.

FLIGrab camera information (lower right hand corner of program)

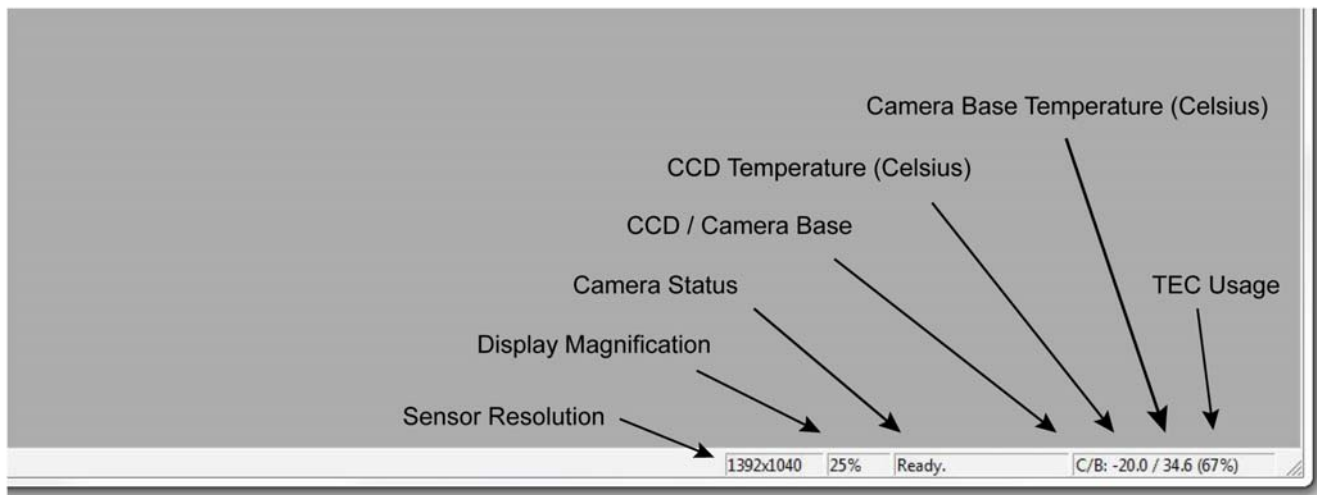

Troubleshooting

Issue	Remedy
I have checked my packing list and items are missing.	In the unlikely event please contact your FLI dealer immediately.
The fan on the camera does not turn.	Check that the camera is plugged to a suitable power supply and that there is power available.
The fan turns but when I use FLIGrab the camera does not work or works erratically.	Make certain that all cables are well seated and are not stretched.
FliGrab runs, the camera fan turns but FLIGrab cannot locate the camera. Sometimes I get a Windows "Communication" error.	Please turn off your computer and camera and leave them switched off for 2-3 minutes. This will flash the USB chips. Try again.
Everything is connected and FLIGrab has been installed but the software cannot locate the camera.	Please make certain that you have installed the software and drivers as per the instructions in this manual. Letting Windows to locate the camera during installation is likely to create problems. Uninstall FLIGrab and install again as per the instructions provided in this manual.
FLIGrab runs and has identified my camera. I have Grabbed an image but the image appears as a flat black frame.	You are over exposing or under exposing. Please read the Capturing your First Image section in this manual.
My images are out of focus. I have problems focusing my camera.	Read the section Focusing your Camera in this manual.

Contact Details

Finger Lakes Instrumentation
 PO Box 19A
 Lima NY 14485 USA
 Tel USA 585-624-3760
 Fax USA 585-624-9879
www.flicamera.com

Appendix

Camera Options

ProLine and MicroLine cameras allow the selection of several types of CCDs that include full frame *front-illuminated*, full frame *back-illuminated*, and *interline* sensors from Kodak, Fairchild Imaging and E2V Technologies.

Sensors Coatings

Several CCD manufacturers have special coatings available to

optimize the sensor's sensitivity for certain wavelengths. ProLine and MicroLine fully support the use of these sensors. Options include UVAR, mid-band and broadband coatings. Contact FLI for details.

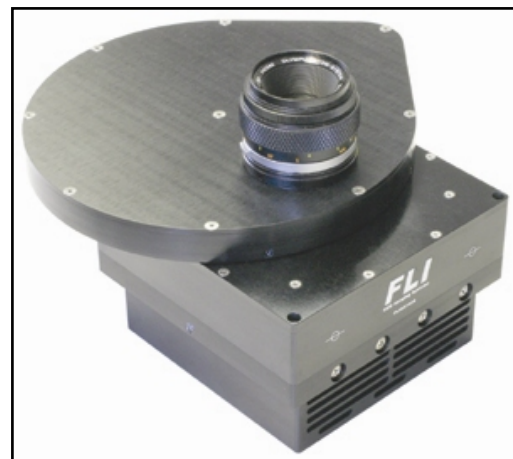

Cooling

All FLI cameras incorporate fan-assisted triple stage TEC cooling that reduces the temperature of the sensor up to 55°C below ambient for MicroLine and 65°C below ambient for ProLine. An LC (liquid cooled) option is available on all cameras that typically improve cooling by another 10 deg.

Celsius. Regardless which camera cooling system is employed, FLI guarantees that our camera systems will operate without encountering 'thermal runaway', requiring special cooling techniques or complex precautionary measures.

Custom Cameras

ProLine and MicroLine imaging systems cameras are designed to accommodate customization. Past applications have included high altitude imaging, x-ray applications, mine searches, ultra cold weather installations, and internal lens mounting within 0.006" of the sensor surface. Please contact FLI for quotes.

External Triggering

The ProLine and MicroLine imaging systems use 6 pin connectors that are labeled “AUX I/O”. The camera shutter can be triggered by shorting pin 5 to pin 6.

In FLIGrab:

- Run FLIGrab
- Select the Shutter Control
- Select the desired triggering on the pull down menu:
 - Select 'External trigger on LOW' for low edge triggering
 - Select 'External trigger on HIGH' for high edge triggering
- Select 'Done'
- Open the Grab Menu
- Select desired frame and exposure settings
- Click the Grab button
- Short pin 3 to pin 2
- The shutter will trigger

Notes:

- Pin 1 – Pin 6 are labeled below.
- Pin 6 is the electrical ground. Pin 5 is the logic input. (This input has a 22.1K pullup resistor to +3.3V).
- Trigger can be set to either rising edge or falling edge. To select the desired edge:
 - Select 'External trigger on HIGH' in the shutter control menu and apply a 0 to +3.3V signal to pin 5.
 - Select 'External trigger on LOW' in the shutter control menu and apply a +3.3V to 0V signal to pin 5.

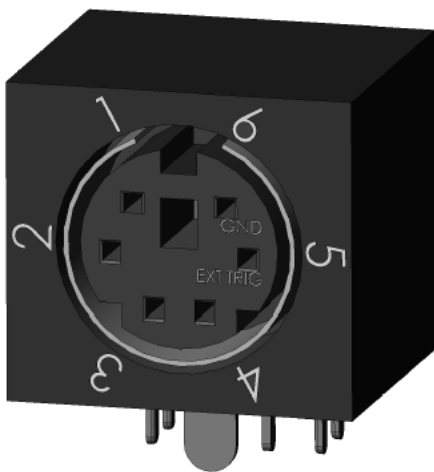

External Trigger for pre-wired systems

1. The Black wire is ground and the yellow wire is the external trigger signal.
2. The external trigger signal (yellow wire) is rated for 0 to 3.3V and it is LVTTL compatible. The edge can be selected in software.
3. The external trigger signal (yellow wire) has a 22.1K pull-up resistor to 3.3V in the camera. This allows the user to simply connect the collector (drain) of a transistor to the yellow wire and the emitter (source) to the black wire if desired. A relay across the two wires will also work.

Shutter Open Indicator

Pin 1 on the AUX I/O connector provides a LVTTL compatible signal for shutter open indication. When the shutter is opened, pin 1 is pulled to +3.3V through an internal 22.1Kohm resistor. When the shutter is closed, pin 1 is pulled down to ground through a 332-ohm resistor within the camera. Pin 6 is the ground reference for this signal.